

# WILPU®

saw blades



# SADRŽAJ:

List ubodne testere: HC 123, HC 12, HC 12K, HC 12R, HC 22DV	3
List ubodne testere: HGS 14, HGS 34, MG 11, MG 31bi	4
List za univerzalnu testeru: 3021, 3026, 1014C/225, 810F/150, 3014/150	5
List za univerzalnu testeru: 3061, 3049, 3048, RWM	6
Pribor za oscilirajuće električne alate: OSZ 126, OSZ 133, OSZ 225, OSZ 184	7
Pribor za oscilirajuće električne alate: OSZ 160, OSZ 222, OSZ 106	8
Pribor za burgije za krune (otvorne testere) ZE 2, Ze4, Krana za metal 8% Co	9
Testere za povlačenje (Japanske testere) Stolarska testera „SPEEDY – super oštra“ Klasična testera za povlačenje „DOZUKI 240“ Klasična testera za povlačenje „RYOBA 240“	10
Wilpu testere za metal, bimetalne Kvalitetna metalna testerica 237 „Puk“-testera – Zamenska sečiva 238b Metalna testerica 242 Testerica sa okvirom Sečivo	11
Skalepri WCM 001 EXPERT, WCM 002 PRO, WCM 004 PREMIUM	12
Skalepri WCM 005 HEAVY PREMIUM, WCM 006 PRO 9	13

Napomena: Navedene cene su bez PDV-a.

# List ubodne testere

## HC 123



Konusno brušeni, zubi trostruko koso brušeni.  
Posebno pogodno za čiste i brze rezove u svim vrstama drveta i plastike (3-60 mm).

Šifra	Materijal	Zubi po inču	Zupčasta dužina	Dimenzija	Pakovanje	Cena
0210500005	HCS/CV	2,5mm/10tpi	91mm	117x10x1,45mm	5	1.137,50
0210500025					25	179,17



## HC 12



Konusno brušeno, zubi ukršteno brušeni.  
Čisti rez; sve vrste drveta, plastike (3-30 mm).

Šifra	Materijal	Zubi po inču	Zupčasta dužina	Dimenzija	Pakovanje	Cena
0211000005	HCS/CV	2,5mm/10tpi	75mm	100x7,8x1,45mm	5	783,33
0211000099					100	133,33



## HC 12K



Konusno brušeno, zubi ukršteno brušeni, oštri zubi.  
Čisti rezovi u krivim linijama u mekom drvetu, šperploči, obloženim pločama (1,5-15 mm).

Šifra	Materijal	Zubi po inču	Zupčasta dužina	Dimenzija	Pakovanje	Cena
0211300005	HCS/CV	1,35mm/19tpi	50mm	76,5x4,5x1,25mm	5	725,00

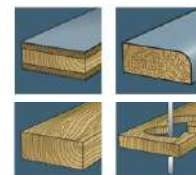

## HC 12R



Konusno brušeno, zubi ukršteno brušeni, zubi na dodir.  
Čisti, bez čipsa, rezovi na površini u svim vrstama drveta, plastici (3-30 mm).

Šifra	Materijal	Zubi po inču	Zupčasta dužina	Dimenzija	Pakovanje	Cena
0211400005	HCS/CV	2,5mm/10tpi	75mm	100x7,8x1,45mm	5	812,50

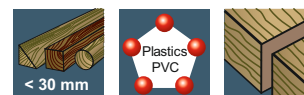

## HC 22DV



Konusno brušeno, zubi ukršteno brušeni za čiste rezove u krivim linijama u laminatima, parketu, mekom drvetu, pločama od vlaknastih ploča, plastično obloženim pločama/HPL, multiplex pločama (2,5-35 mm).

Šifra	Materijal	Zubi po inču	Zupčasta dužina	Dimenzija	Pakovanje	Cena
0217600002	HCS/CV	2,5mm/10tpi	75mm	100x6,5x1,45mm	2	425,00
0217600005					5	925,00

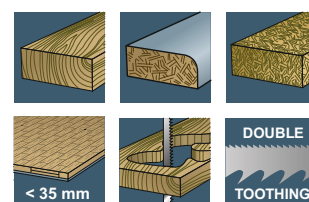

# List ubodne testere

## HGS 14



Zubi razmaknuti i koso naoštreni.  
Brz rez; univerzalno sečivo za sve vrste drveta (5-50 mm).



Šifra	Materijal	Zubi po inču	Zupčasta dužina	Dimenzija	Pakovanje	Cena
0236000005	HCS/CV	4mm/6,35tpi	75mm	100x7,8x1,27mm	5	579,17

## HGS 34



Zubi razmaknuti i koso naoštreni.  
Brz rez; ekstra dugačko univerzalno sečivo za sve vrste drveta (5-80 mm).



Šifra	Materijal	Zubi po inču	Zupčasta dužina	Dimenzija	Pakovanje	Cena
0238000005	HCS/CV	4mm/6,35tpi	105mm	132x7,8x1,27mm	5	1.208,33

## MG 11



Zubi frezovani i talasasto oblikovani.  
Tanki čelični limovi (1,2-3 mm).

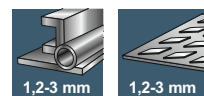

Šifra	Materijal	Zubi po inču	Zupčasta dužina	Dimenzija	Pakovanje	Cena
0255000005	HSS	1,2mm/21tpi	55mm	76,5x7,8x1mm	5	740,83
0255000025					25	133,33

## MG 31 bi

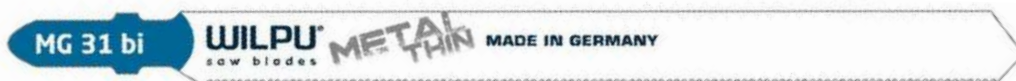

Zubi frezovani i talasasto oblikovani.  
Dugačko, fleksibilno sečivo za čelik (1-3 mm), profile, cevi i sendvič materijale do 80 mm.  
Dug vek trajanja.



Šifra	Materijal	Zubi po inču	Zupčasta dužina	Dimenzija	Pakovanje	Cena
0257100002	Bimetal	1,1mm/22tpi	105mm	132x9,8x1mm	2	708,33



# List za univerzalnu testeru

3021



Zubi ukršteno brušeni i razmaknuti; za brze, ravne rezove u svim vrstama drveta, plastike i gips-kartona (6-100 mm).

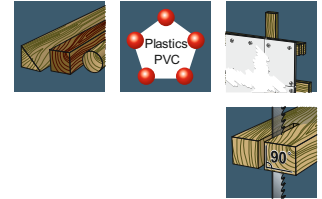

Šifra	Materijal	Zubi po inču	Zupčasta dužina	Dimenzija	Pakovanje	Cena
1221500002			130mm	150x19x1,27mm	2	716,67
1221500020	HCS/CV	4mm/6tpi	130mm	150x19x1,27mm	20	300,00
1223000005			280mm	300x19x1,27mm	5	2.583,33

3026



Kao što je gore opisano.

Duže sečivo 3026/370 PC je zakrivljeno za brže rezove i posebno pogodno za radove na rezanju svežeg (zelenog) drveta.

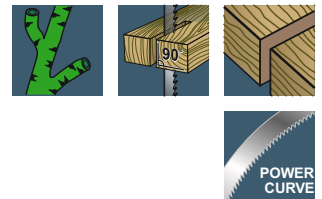

Šifra	Materijal	Zubi po inču	Zupčasta dužina	Dimenzija	Pakovanje	Cena
1282000002	HCS/CV	4,2mm/6tpi	245mm	275x30x1,4mm	2	3.329,17

1014C/225



Zubi frezovani i razmaknuti.

Vario zubni profil.

Pogodno za sve vrste drveta sa metalnim ostacima; čelik od 2,5 mm.

Posebno dizajnirano za popravku paleta.

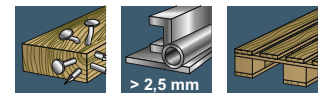

Šifra	Materijal	Zubi po inču	Zupčasta dužina	Dimenzija	Pakovanje	Cena
1352200002	Bimetal	2,5/1,8mm/10/14	205mm	225x19x0,9mm	2	1.325,00

810F/150



Vario zubni profil.

Ekstra debelo sečivo za ravne rezove u svim vrstama drveta sa metalnim ostacima; čelik od 3 mm.

Posebno dizajnirano za demontažu prozora.

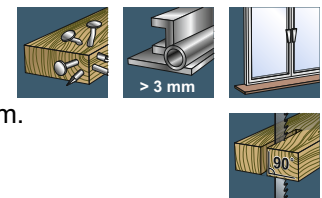

Šifra	Materijal	Zubi po inču	Zupčasta dužina	Dimenzija	Pakovanje	Cena
1365000002	Bimetal	3,2/2,2mm/8/10	130mm	150x19x1,27mm	2	1.125,00

3014/150



Zubi frezovani i talasasto oblikovani.

Fleksibilno univerzalno sečivo za čelik i nerđajući čelik od 2 mm naviše.

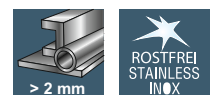

Šifra	Materijal	Zubi po inču	Zupčasta dužina	Dimenzija	Pakovanje	Cena
1441500005			130mm	150x19x0,9mm	5	1.791,67
1442000005	Bimetal	1,4mm/18tpi	180mm	200x19x0,9mm	5	2.241,67

# List za univerzalnu testeru

3061



Zubi frezovani i razmaknuti.

Široko visokoperformansno sečivo sa TWIN-CUT zubnim profilom za precizne i ravne rezove u čeličnim cevima, profilima, obojenim metalima (3-12 mm) i drvetu sa metalnim ostacima (< 100 mm / < 175 mm / < 250 mm).

Do 5 puta brže od standardnih sečiva za rušenje.

TWIN-CUT zubni profil izrađen je od specijalnog, prahometalurški proizvedenog ASP alata, sa najvišim sadržajem legura, što omogućava:

Veću žilavost

Veću radnu tvrdoću

Duži vek trajanja u poređenju sa standardnim bimetalnim/HSS sečivima.

Šifra	Materijal	Zubi po inču	Zupčasta dužina	Dimenzija	Pakovanje	Cena
1541600005	Bimetal	2,5/1,8mm-10/14tpi	130mm	150x25x1,1mm	5	2.825,00
1542200005			205mm	225x25x1,1mm	5	3.741,67

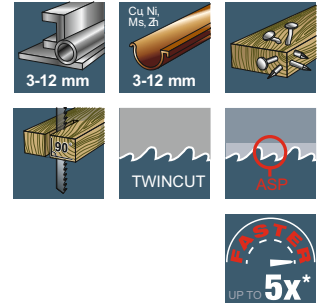

3049



Specijalno sečivo sa HM (hard metal) zubima, za nerđajući čelik, metal, obojene metale, armaturu, SML liveno gvožđe i gumu ojačanu metalom, dubine rezanja do <100 mm / <175 mm / <250 mm.

Šifra	Materijal	Zubi po inču	Zupčasta dužina	Dimenzija	Pakovanje	Cena
1661500001	HM/T.C.T.	3,2mm/8tpi	130mm	150x25x1,3mm	1	2.491,67
1662200001			205mm	225x25x1,3mm	1	3.733,33



3048



Tvrdometalni (HM) zubi, za brze rezove u visoko abrazivnim specijalnim materijalima, npr. Poroton, gasni beton itd.

Ekstra široko sečivo za rezove pod pravim uglom do <215 mm / <365 mm.

Pogodno za mašine sa snagom od 1.000 W i više.

Šifra	Materijal	Zubi po inču	Zupčasta dužina	Dimenzija	Pakovanje	Cena
1664500001	HM/T.C.T.	12,5mm/2tpi	410mm	455x50x1,5mm	1	5.825,00

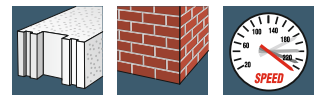

RWM



Dvostruko talasasto brušenje.

Brzi i izuzetno čisti rezovi u mineralnoj vuni, penastim materijalima (EPS/PUR),

stiroporu, Styroduru, koži, gumi, papiru i tepihu do 100 mm / 175 mm / 250 mm / 400 mm.

Šifra	Materijal	Zubi po inču	Zupčasta dužina	Dimenzija	Pakovanje	Cena
1602200002	HCS/CV	-	205mm	225x19x1,27mm	2	2.658,33
1603000002			280mm	300x19x1,27mm	2	3.991,67
1604500002			430mm	450x19x1,27mm	2	5.245,83

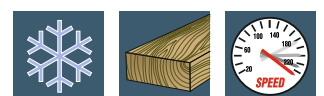

# Pribor za oscilirajuće električne alate.

## OSZ 126



Usko, suženo sečivo za brzo uklanjanje strugotine i dobar napredak pri sečenju sa trostruko brušenim japanskim zubima: precizan, brz rez; pogodno za sve vrste drveta, meke plastike i gips-karton.



Šifra	Materijal	Dubina rezanja	Dimenzija	Pakovanje	Cena
2312600001	HCS/CV	40mm	50x35mm	1	2.408,33

## OSZ 133



Usko, suženo sečivo za brzo uklanjanje strugotine i dobar napredak pri sečenju, sa razmaknutim zubima; pogodno za sve vrste drveta, plastiku i gips-karton.

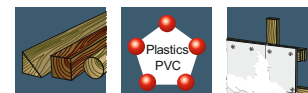

Šifra	Materijal	Dubina rezanja	Dimenzija	Pakovanje	Cena
2313300001	HCS/CV	40mm	50x35mm	1	1.991,67
2313300099	HCS/CV	40mm	50x35mm	100	1.658,33

## OSZ 225



Ekstra široko i zakrivljeno sečivo sa razmaknutim zubima za idealno ponašanje pri ulasku u materijal i posebno čiste i precizne površinske rezove.

Brzi i precizni dugi rezovi; pogodno za sve vrste drveta, plastiku i gips-karton.

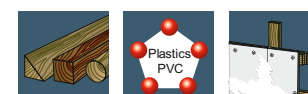

Šifra	Materijal	Dubina rezanja	Dimenzija	Pakovanje	Cena
2322500001	HCS/CV	65mm	50x65mm	1	2.408,33

## OSZ 184



Kratko, usko sečivo sa razmaknutim zubima; za sve vrste drveta sa metalnim ostacima do 4 mm, ostatke zida, plastiku i gips-karton. Povećan vek trajanja.



Šifra	Materijal	Dubina rezanja	Dimenzija	Pakovanje	Cena
2318400001	Bimetal	40mm	50x10mm	1	1.375,00

# Pribor za oscilirajuće električne alate.

## OSZ 160



Usko, suženo sečivo za brzo uklanjanje strugotine i efikasan napredak pri sečenju, sa razmaknutim hoblovanim zubima; pogodno za sve vrste drveta sa metalnim i građevinskim ostacima, plastiku i gips-karton. Povećan vek trajanja.



Šifra	Materijal	Dubina rezanja	Dimenzija	Pakovanje	Cena
2316000001	HCS/CV	40mm	50x35mm	1	2.491,67
2316000099				100	1.875,00

## OSZ 222



Usko sečivo za brzo uklanjanje strugotine i efikasan napredak pri sečenju, sa talasastim univerzalnim zubima; pogodno za sve vrste drveta, plastiku, gips-karton, tanke limove do 2 mm, aluminijum i obojene metale. Povećan vek trajanja.

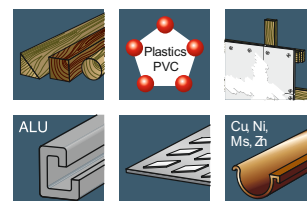

Šifra	Materijal	Dubina rezanja	Dimenzija	Pakovanje	Cena
2322200001	HCS/CV	40mm	50x28mm	1	2.575,00
2322200099				100	2.158,33

## OSZ 106



Segmentno sečivo, idealno za rad u uglovima bez presecanja van zadate linije.

Prečnik = 85 mm; precizan i čist rez; pogodno za limove do 1 mm, plastiku, ugljenične kompozite (CFK), staklene kompozite (GFK), drvo, kit i obojene metale.

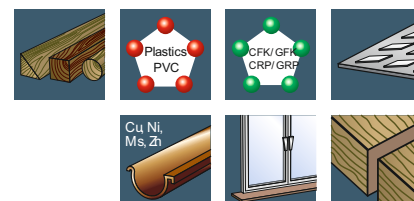

Šifra	Materijal	Dubina rezanja	Dimenzija	Pakovanje	Cena
2310600001	HCS/CV	20mm	ø=85mm	1	3.741,67





# Pribor za burgije za krune (otvorne testere)

## ZE 2

Držač testere sa šestougaonim priključkom, prečnika 9,5 mm (za otvore 14-30 mm), sa centrirajućom burgijom prečnika 6,3 mm i dužine 83 mm.

Šifra	Cena
3030200001	1.158,33



## ZE 4

Držač testere sa šestougaonim priključkom, prečnika 11 mm (za otvore 32-250 mm), sa centrirajućom burgijom prečnika 6,3 mm i dužine 83 mm.

Šifra	Cena
3030400001	2.158,33



## Kruna za metal 8% Co

WILPU Bimetal Krunske Testere 10 ZPZCOBALT TOP FEIN – Proizvedeno u Nemačkoj  
Fina zupčasta geometrija sa 10 zuba po inču, izrađena od visokokvalitetnog bimetala legiranog kobaltom, pruža optimalan kvalitet sečenja i dug vek trajanja.  
Masivni zadnji poklopac omogućava stabilan rad, visoku preciznost i glatko sečenje, idealno za bušenje rupa za navoje, kablove i cevi.

Posebno pogodno za:

Čelik i nerđajući čelik

Limove debljine do 1 mm



○	Šifra	Dimenzija	Dijametar	Cena
31/30	3103000101	30mm	1 3/16inch	1.575,00
31/35	3103500101	35mm	1 3/8inch	1.575,00
31/40	3104000101	40mm	1 9/16inch	1.658,33
31/44	3104400101	44mm	1 3/4inch	1.750,00
31/51	3105100101	51mm	2inch	1.875,00
31/54	3105400101	54mm	2 1/8inch	1.908,33
31/60	3106000101	60mm	2 3/8inch	2.125,00
31/68	3106800101	68mm	2 11/16inch	2.375,00
31/79	3107900101	79mm	3 1/8inch	2.499,17
31/83	3108300101	83mm	3 17/64inch	2.499,17
31/102	3110200101	102mm	4inch	3.825,00

BiM  
8% COBALT

10  
ZpZ • tpi • d/p  
Fein

38 mm  
1 1/2 inch



ROSTFREI  
STAINLESS  
INOX



## Testere za povlačenje (Japanske testere)

### Stolarska testera „SPEEDY – super oštra“

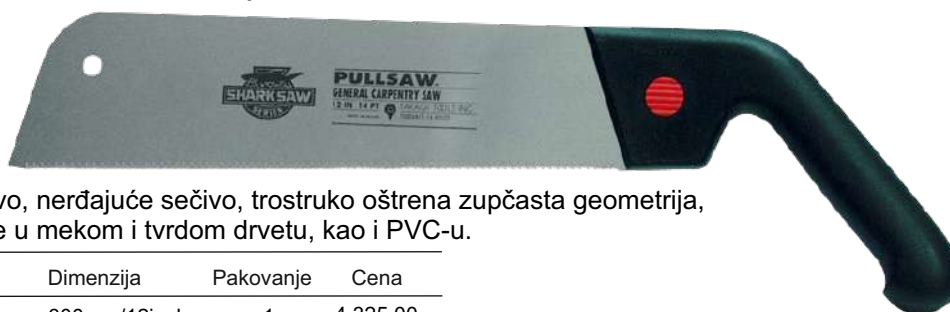

priključak za sečivo



Plastična drška, zamenjivo, nerđajuće sečivo, trostruko oštrena zupčasta geometrija, za precizne, čiste rezove u mekom i tvrdom drvetu, kao i PVC-u.

Šifra	Zubi po inču	Dimenzija	Pakovanje	Cena
361000000	1,8mm/14tpi	300mm/12inch	1	4.325,00

### Klasična testera za povlačenje „DOZUKI 240“



priključak za sečivo



Drška od ratana, zamenjivo, nerđajuće sečivo, trostruko oštrena, impulsno otvrdnuta zupčasta geometrija za izuzetno dug vek trajanja i precizne, čiste rezove u tvrdim i mekim drvetima. Preporučuje se za sečenje poprečno na vlakna.

Šifra	Zubi po inču	Dimenzija	Pakovanje	Cena
362100000	1,3mm/20tpi	240mmx0,3mm*9,5"	1	6.575,00

### Klasična testera za povlačenje „RYOBA 240“

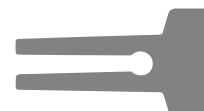

priključak za sečivo

Drška od ratana, zamenjivo, nerđajuće sečivo, praktična testera, univerzalna testera sa dvostruko zupčastim sečivom za duboke rezove poprečno (20 zuba po inču) i uzdužno (8 zuba po inču) na vlakna. Impulsno otvrdnuta zupčasta geometrija za izuzetno dug vek trajanja i precizne, čiste rezove u tvrdim i mekim drvetima.

Šifra	Zubi po inču	Dimenzija	Pakovanje	Cena
364100000	1,2/3,2-20/8tpi	240mmx0,5mm*9,5"	1	7.912,50



## Wilpu testere za metal, bimetalne

Šifra	Zubi po inču	Dimenzija	Pakovanje	Cena
3723500099	1mm/24tpi	300mm/13inch	10	250,00



## Kvalitetna metalna testerica 237

Šifra	Cena
5023700000	1.750,00



Metalna testerica sa drškom od drveta i krilnom maticom za brzo zatezanje sečiva.

Dimenzije okvira: 17 x 7 mm.

Uključuje bimetalnu testeru, 300 mm, 24 zuba po inču.

## „Puk“-testera – Zamenska sečiva 238b



Dužina sečiva: 150 mm Dužina: 6 inča Dužina oštice: 150 mm

Šifra	Dužina	Zubi po inču	Pakovanje	Cena
5023802012	150mm/6"	0,8mm/32tpi	12	1.491,67

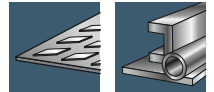

## Metalna testerica 242

Juniorska testera (150 mm) od aluminijumskog liva, sa 2-komponentnom mekanom drškom.

Zamena i zatezanje sečiva pomoću matice.



Šifra	Dužina	Zubi po inču	Cena
5024200000	150mm/6"	1mm/25tpi	1.575,00

## Testera sa okvirom



Šifra	Dužina	Zubi po inču	Cena
4551020762	762mm	7mm/3,5pi	1.625,00

Od čelične cevi sa udarno otpornim praškastim premazom.

2-komponentna drška za visok ergonomskih komfor i sigurnost.

Jednostavna i sigurna zamena sečiva pomoću ergonomske zavrtanj za visok stepen napetosti sečiva i ravne rezove.

Saečivo za svež drveni materijal, induktivno otvrdnuto.

## Sečivo



Iz visokokvalitetnog trakastog čelika, sa škarastim zupcima, nagnuto oštrenim, induktivno otvrdnuto.

Šifra	Dužina	Zubi po inču	Cena
4047020762	762mm	7mm/3,5pi	575,00

# WCM 001 EXPERT

Šifra	Cena
5090000024	375,00
5090400020	650,00

Stabilna, nerđajuća vodilica od galvanizovanog metala sa automatskim zaključavanjem oštrice.

Protivklizni i opruženi klizač za brzo pomeranje napred i nazad, sa automatskim zaključavanjem oštrice.

Integrirani prekidač oštrice

Ekstra oštra 18 mm Black Diamond oštrica za lomljenje sa 14 segmenta za lomljenje i 15 koristi.

2 zamenske oštrice u dršci.

Ergonomska, protivklizna, na kiselinu i udarce otporna plastična drška.

Opruga za kačenje ili okačenje.

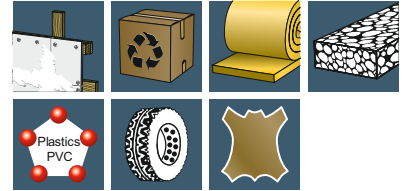

# WCM 002 PRO

Šifra	Cena
5090100024	533,33
5090400020	650,00

Stabilna, nerđajuća vodilica od galvanizovanog metala sa automatskim zaključavanjem oštrice.

Protivklizni i opruženi klizač za brzo pomeranje napred i nazad, sa automatskim zaključavanjem oštrice.

Integrirani prekidač oštrice

Ekstra oštra 18 mm Black Diamond oštrica za lomljenje sa 14 segmenta za lomljenje i 15 koristi.

2 zamenske oštrice u dršci.

Ergonomska 2-komponentna drška od plastike otporne na kiselinu i udarce, sa prijatnim, protivkliznim gumenim omotačem.

Opruga za kačenje ili okačenje.



# WCM 004 PREMIUM

Šifra	Cena
5090300024	1.066,67

Stabilna, nerđajuća vodilica od galvanizovanog metala sa automatskim zaključavanjem oštrice.

Protivklizni i opruženi klizač za brzo pomeranje napred i nazad, sa automatskim zaključavanjem oštrice.

Integrirani prekidač oštrice

Ekstra oštra 18 mm Black Diamond oštrica za lomljenje sa 14 segmenta za lomljenje i 15 koristi.

Opruga za kačenje ili okačenje.

Teška ergonomska 2-komponentna drška od livenog cinka otpornog na koroziju, sa prijatnom, protivkliznom gumenom umetkom.

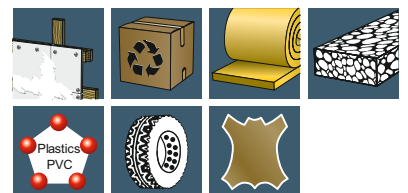

## WCM 005 HEAVY PREMIUM



Naziv	Šifra	Cena
WCM005P	5090500006	2.245,83
WCRB002 trapezni nožić	5090700020	625,00







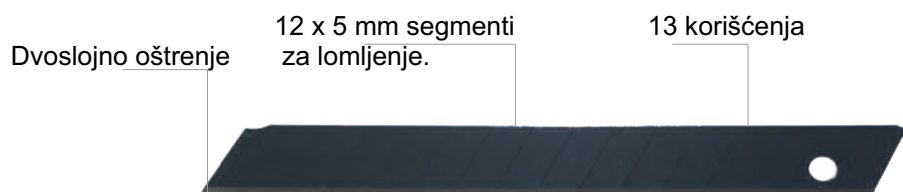

































## WCM 006 PRO 9









Naziv	Šifra	Cena
WCM006P	5090800012	375,00
WCRB004 zamenski nož	5090900010	541,67



# LEGENDA PIKTOGRAMA

	Svi tipovi drveta		ALU Aluminijum		Stiropol		Guma
	Meko drvo		Cu, Ni, Ms, Zn Obojeni metal		Gipskarton		Koža
	Dvrdo drvo		Liveni čelik		Plastika ojačana staklenim vlaknima Fibreglass		Led/Smrznuta hrana
	Sperploča		PU-cevi		Pleksiglas		Beton
	Laminat		ROSTFREI STAINLESS INOX Nerđajući čelik		Staklo		Kamen
	Iverica		Plastics PVC Plastika		Demontaža prozora		Popravka paleta
	Laminati i parketi		CFK/GFK CRP/GRP Plastika ojačana ugljeničnim vlaknima		Keramika		Papir
	Zeleno drvo		Sendvič materijal		Fuge između pločica		Vatrogasna i spasilačka služba
	Drvo sa metalnim ostacima		Izolacioni materijali		Varicor/Corian		
	Čelične cevi, profili, puni materijal		Gas-beton		Cigla/Zidarska opeka		
	Limovi		Eternit		Malter		

## SVOJSTVA

	Zubi na spoj		Paralelni rez		DOUBLE TOOTHING Dvostruka zupčasta struktura		Rezanje krivih linija u metalu
	Brzi rez		Čist rez		TWINCUT TWINCUT TWINCUT zupčasta struktura		Zakrivljena oštrica
	Rezanje krivih linija u drvetu		Grub rez		Pogodno za višefunkcionalnu ručku		Dvostrana ugradnja
	Do 5 puta brže od običnih demoliacionih oštrica				TWINCUT zupčasti profil od ASP		



Moć je u kvalitetu.

**TECHNO-FERUM**

Partizanska 64b, Novi Sad  
+381216410907